

ACTUAL CAPACITY
 BIN: 50.9 CF
 HOPPER: 16.2 CF
 TOTAL: 67.1 CF

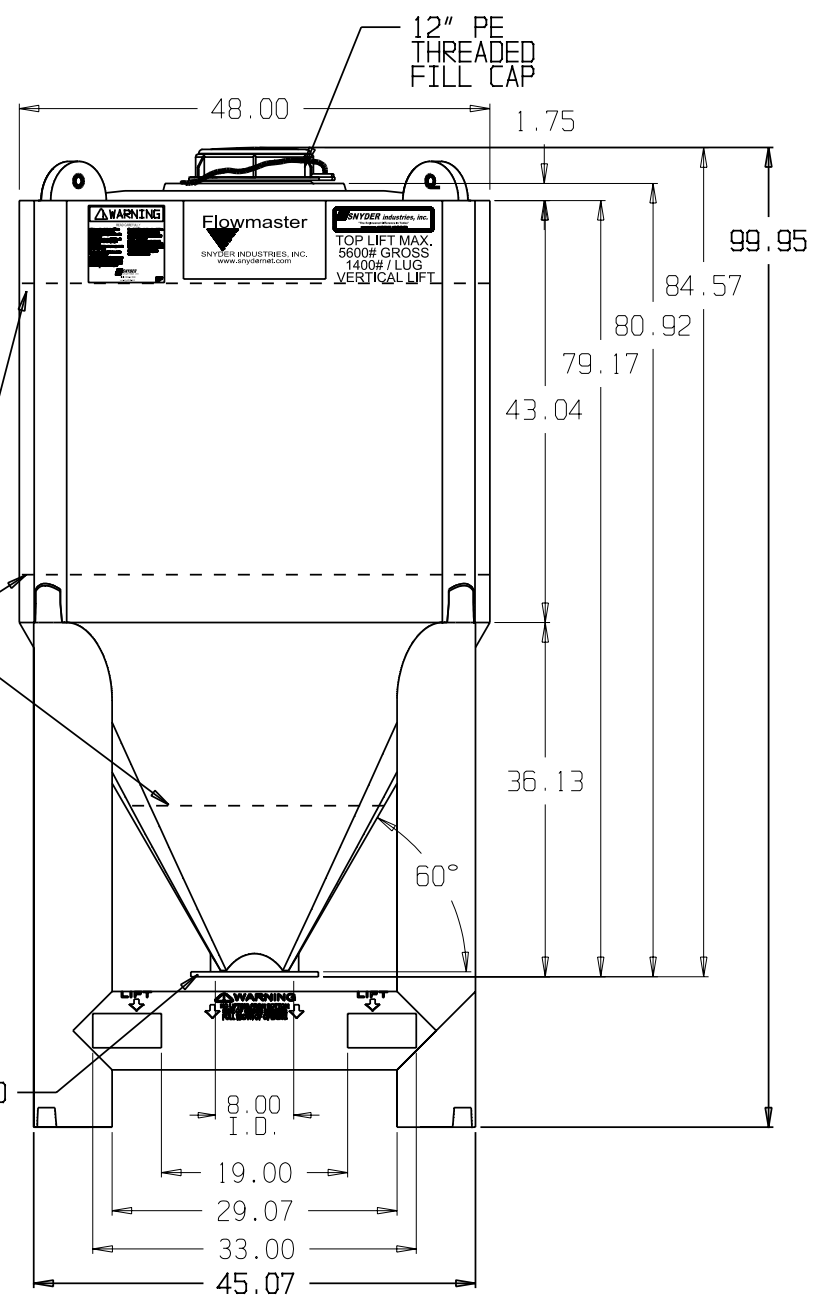
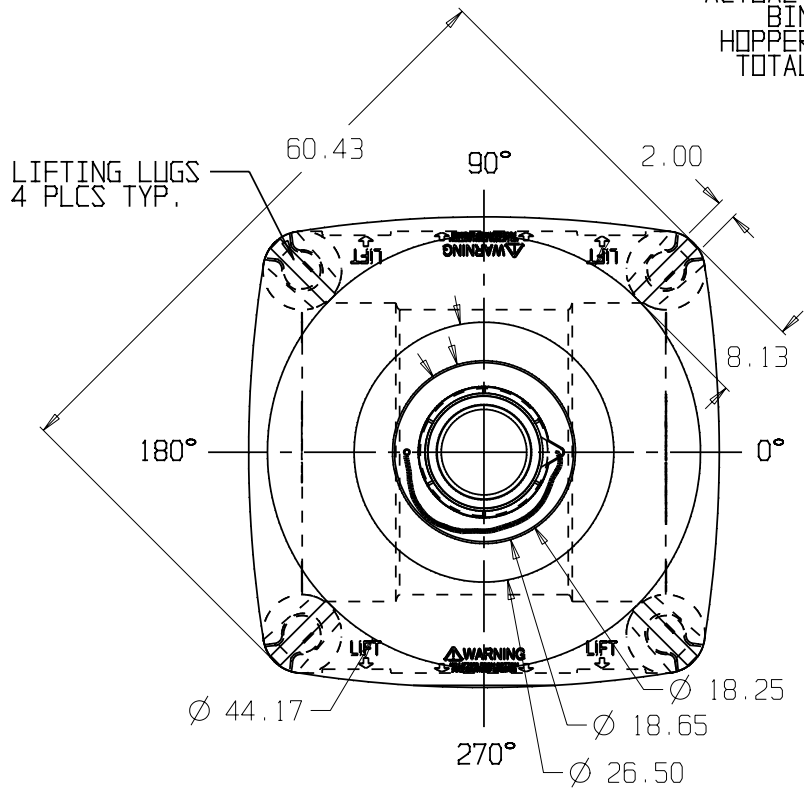

* BASE FITTINGS TO BE LEFT INSTALLED AT TIME OF SHIPMENT PER SII PROCEDURE
 * Consult Snyder's Guidelines for Use and Installation prior to delivery.
 Available on-line at www.snydernet.com

(all dimensions in inches)

PART # BIN: 6371300N--L

BASE: 6390100N--L

REF#: 00000

06/20/05

68 CUBIC FOOT 60° SLOPE CLOSED TOP DRY BIN W/8" Ø OUTLET, 12" FILLCAP & BASE