

ACTUAL CAPACITY  
 BIN: 29.3 CF  
 HOPPER: 16.2 CF  
 TOTAL: 45.5 CF

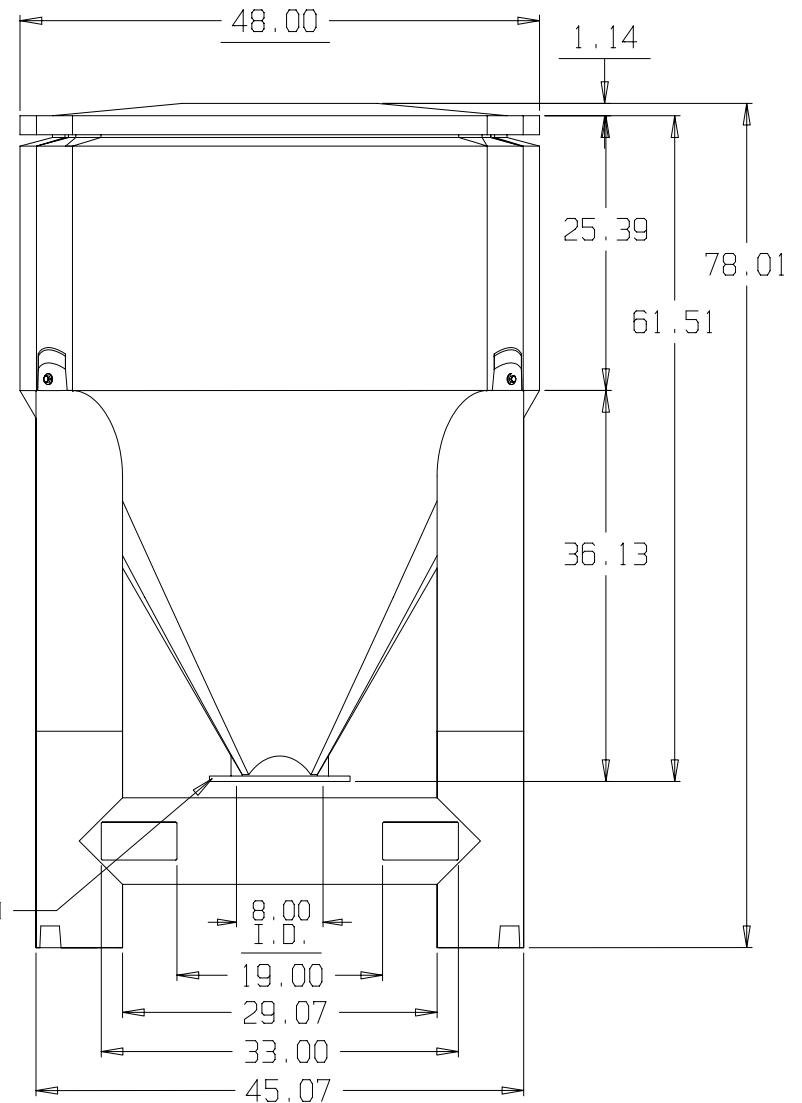

FLANGE TRIMMED  
 FOR SPECIFIC  
 VALVE (Ø WILL  
 VARY)

\* BASE FITTINGS TO BE LEFT INSTALLED AT TIME OF SHIPMENT PER SII PROCEDURE  
 \* Consult Snyder's Guidelines for Use and Installation prior to delivery.  
 Available on-line at [www.snydernet.com](http://www.snydernet.com)

(all dimensions in inches)

PART #s BIN: 6370900N--L

BASE: 6390100N--L

REF#: 00000

06/29/04

48 CUBIC FOOT 60° SLOPE OPEN TOP DRY BIN W/8" Ø OUTLET, NO MANWAY & BASE