

ACTUAL CAPACITY
 BIN: 14.6 CF
 HOPPER: 8.9 CF
 TOTAL: 23.5 CF

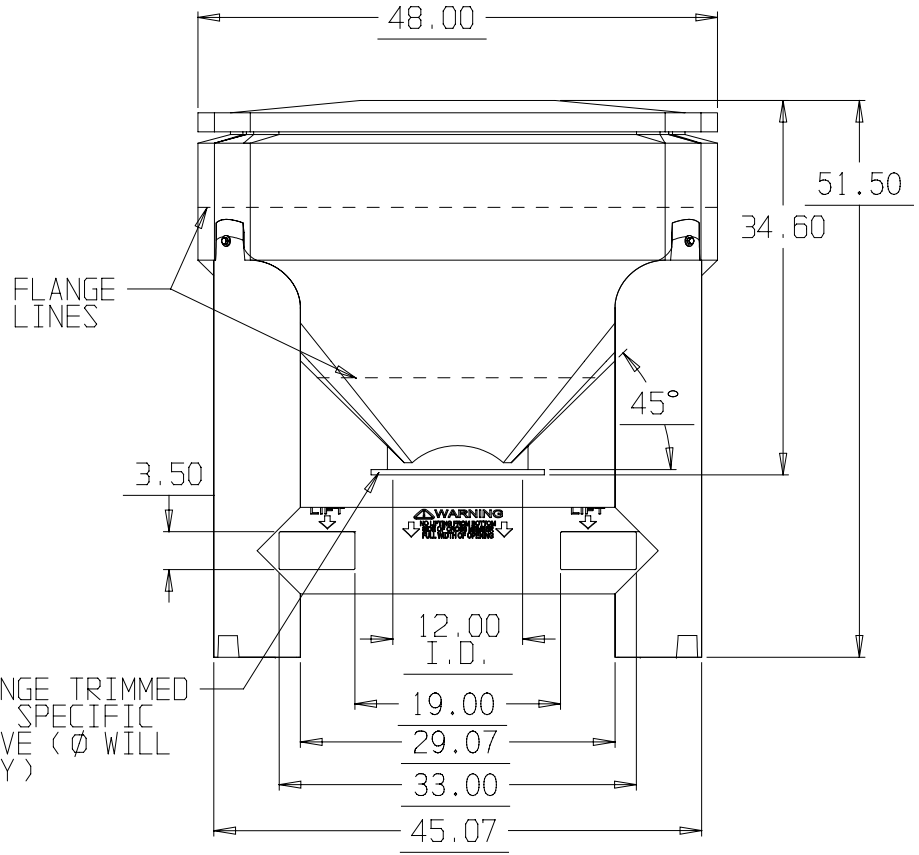

FLANGE TRIMMED
 FOR SPECIFIC
 VALVE (Ø WILL
 VARY)

* BASE FITTINGS TO BE LEFT INSTALLED AT TIME OF SHIPMENT PER SII PROCEDURE
 * Consult Snyder's Guidelines for Use and Installation prior to delivery.
 Available on-line at www.snydernet.com

(all dimensions in inches)

PART #s BIN: 6370001N--L

BASE: 6390000N--L

REF#: 00000

11/12/04

25 CUBIC FOOT 45° SLOPE OPEN TOP DRY BIN W/12" Ø OUTLET, NO MANWAY & BASE